

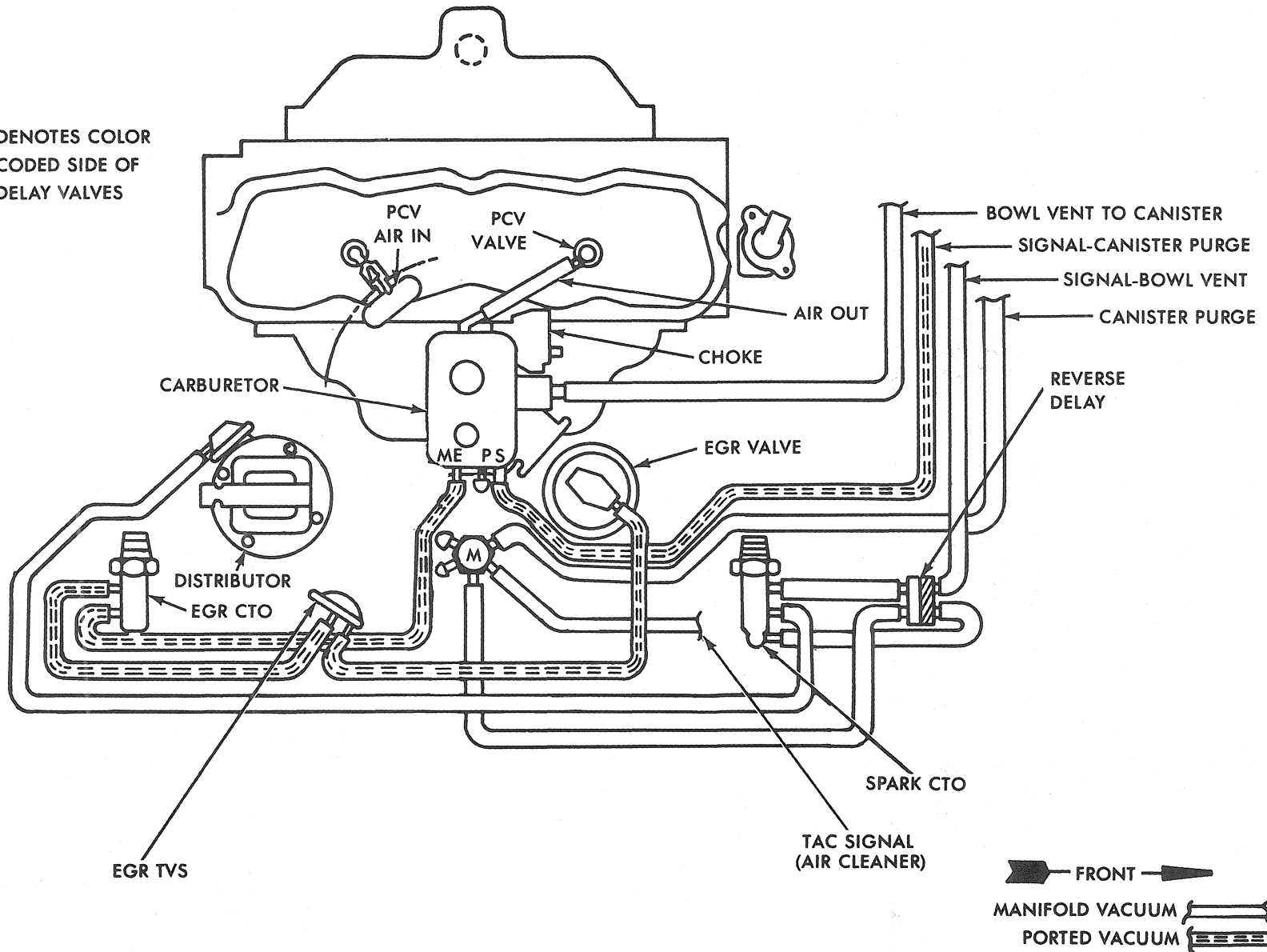

▨ DENOTES COLOR CODED SIDE OF DELAY VALVES



81148A

 DENOTES COLOR
 CODED SIDE OF
 DELAY VALVES

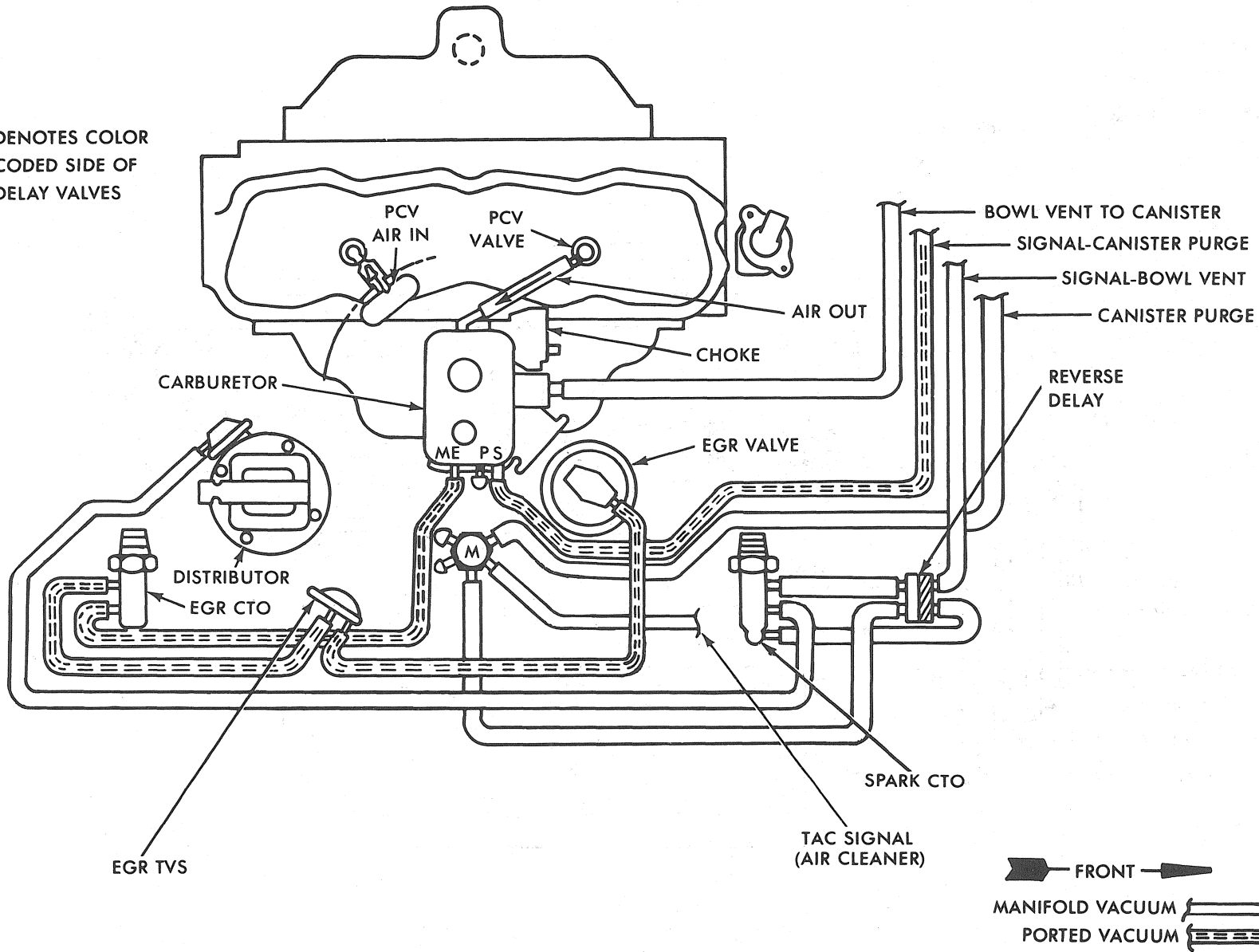

81148B

 DENOTES COLOR CODED SIDE OF DELAY VALVES

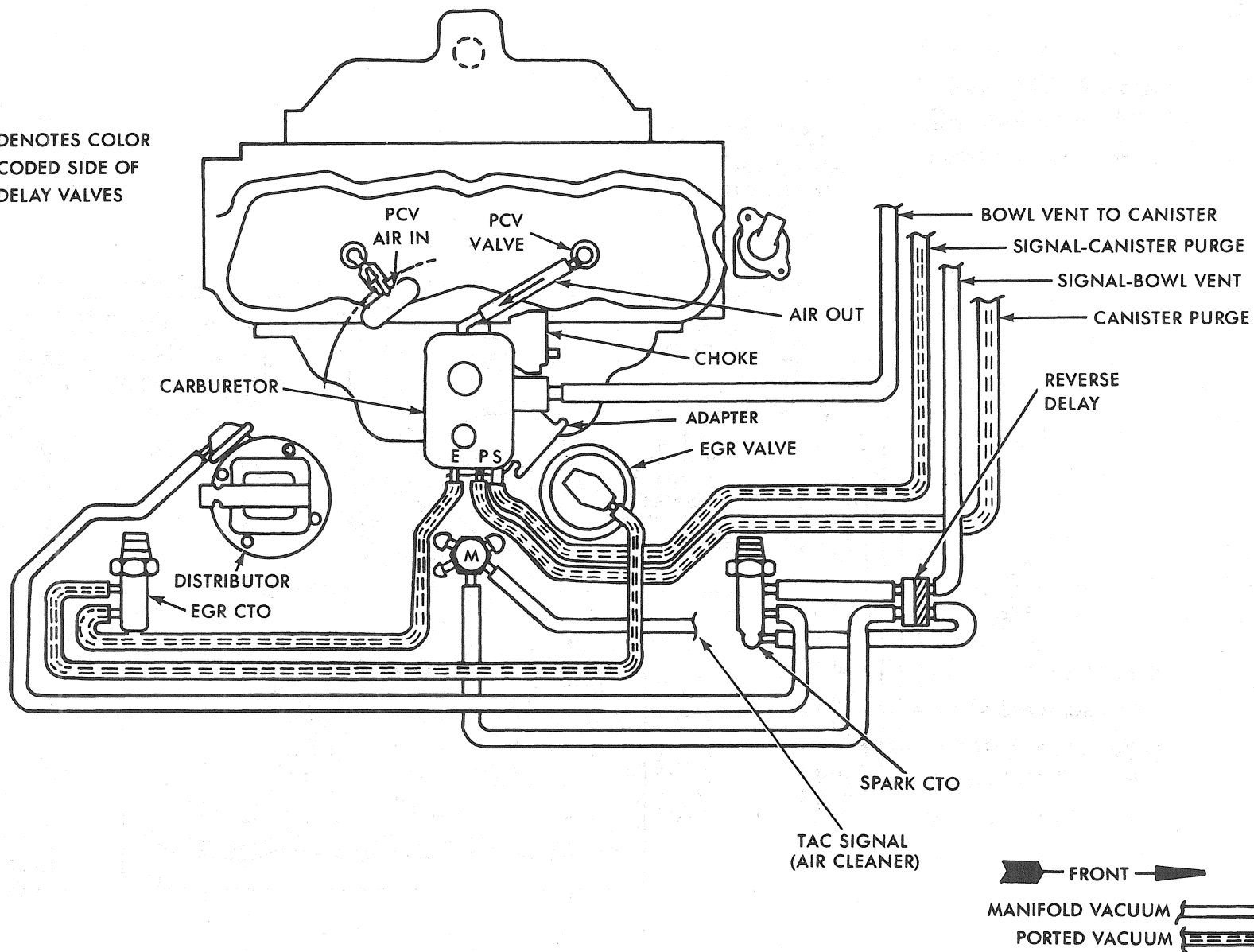

81148C

49 STATE 151 2V WITH AUTOMATIC TRANSMISSION AND STANDARD COOLING CJ

 DENOTES COLOR
 CODED SIDE OF
 DELAY VALVES

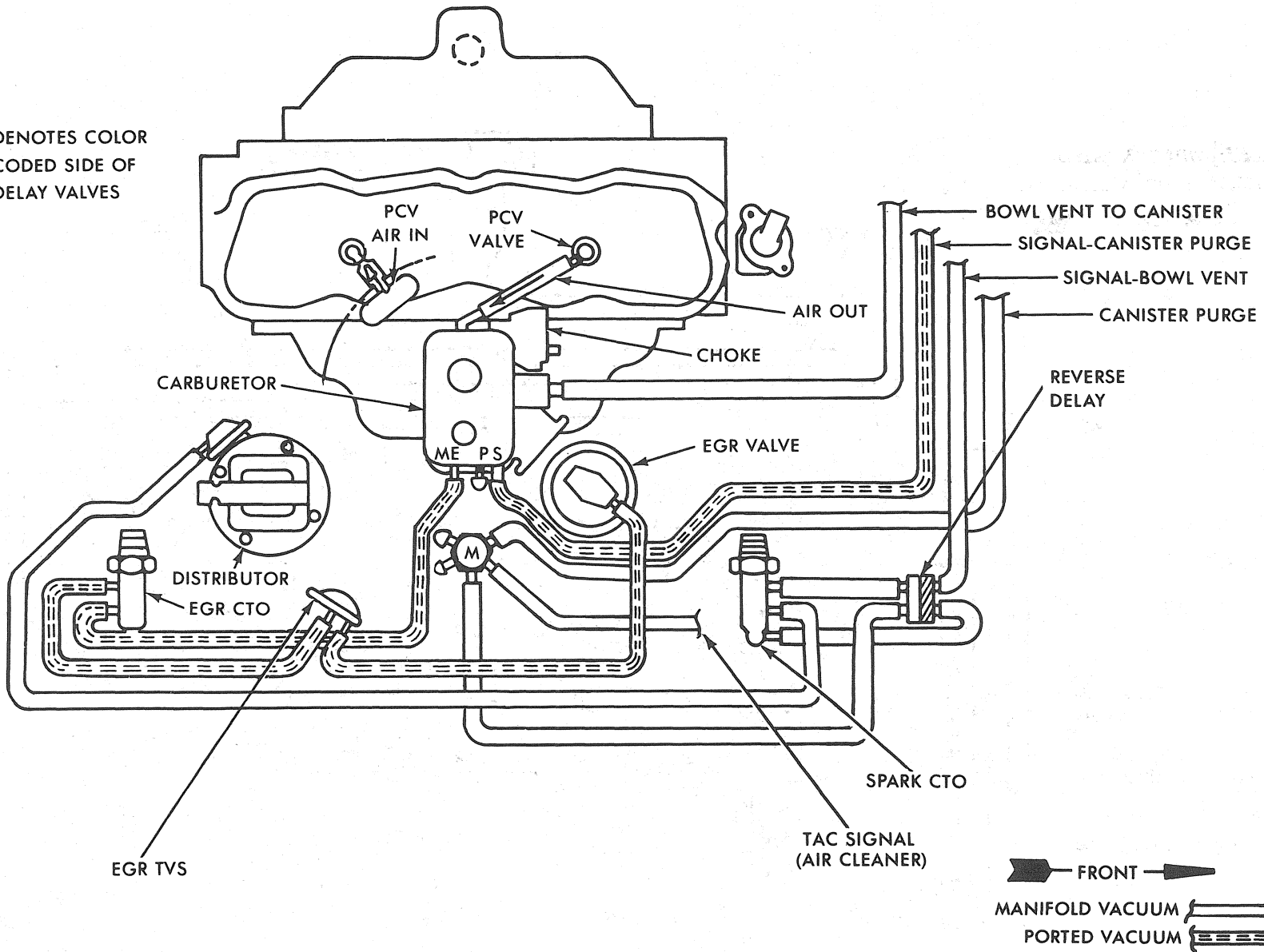

81148D

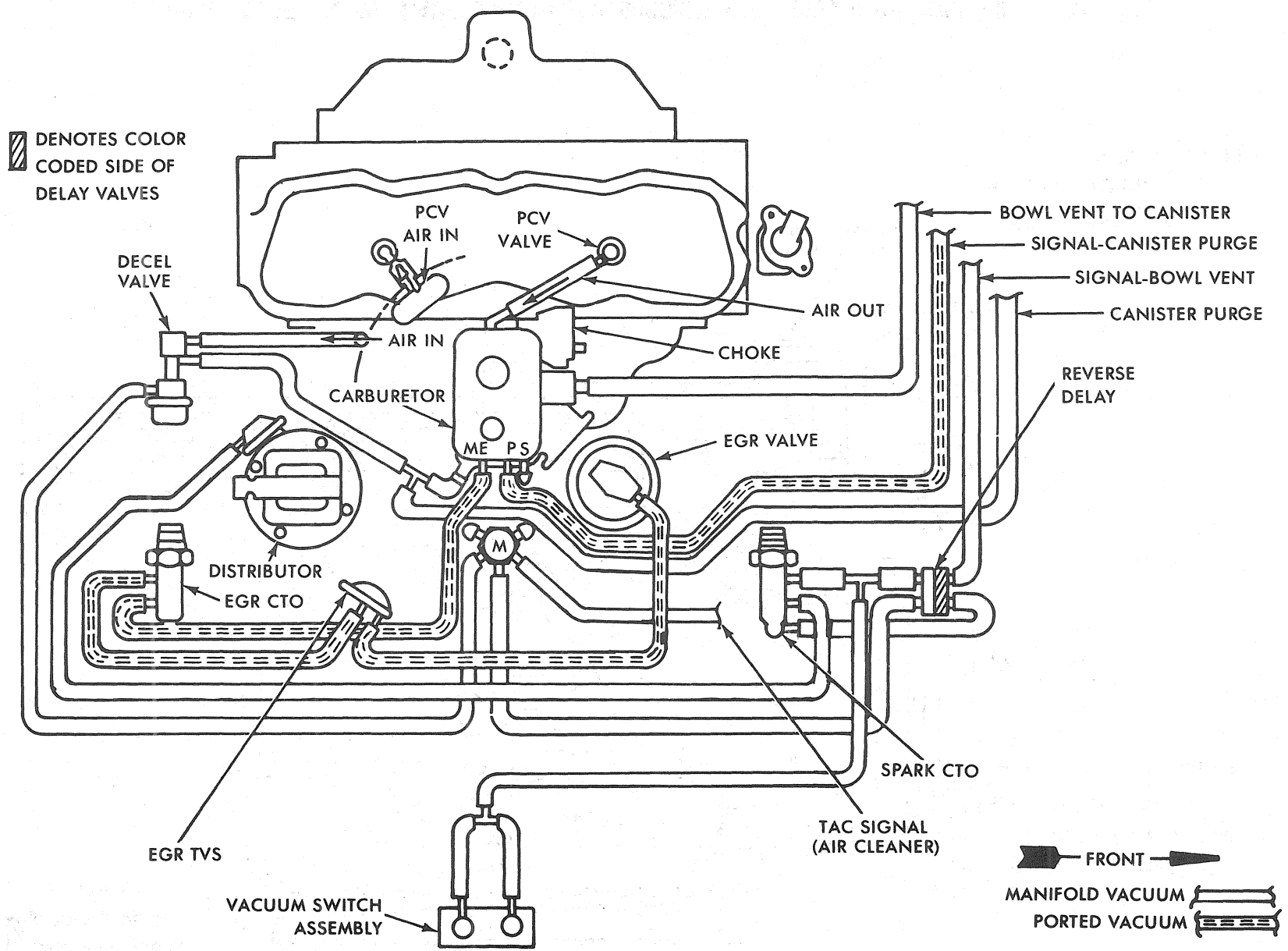

81148E

CALIFORNIA 151 2V WITH MANUAL TRANSMISSION AND STANDARD COOLING CJ

 DENOTES COLOR
 CODED SIDE OF
 DELAY VALVES

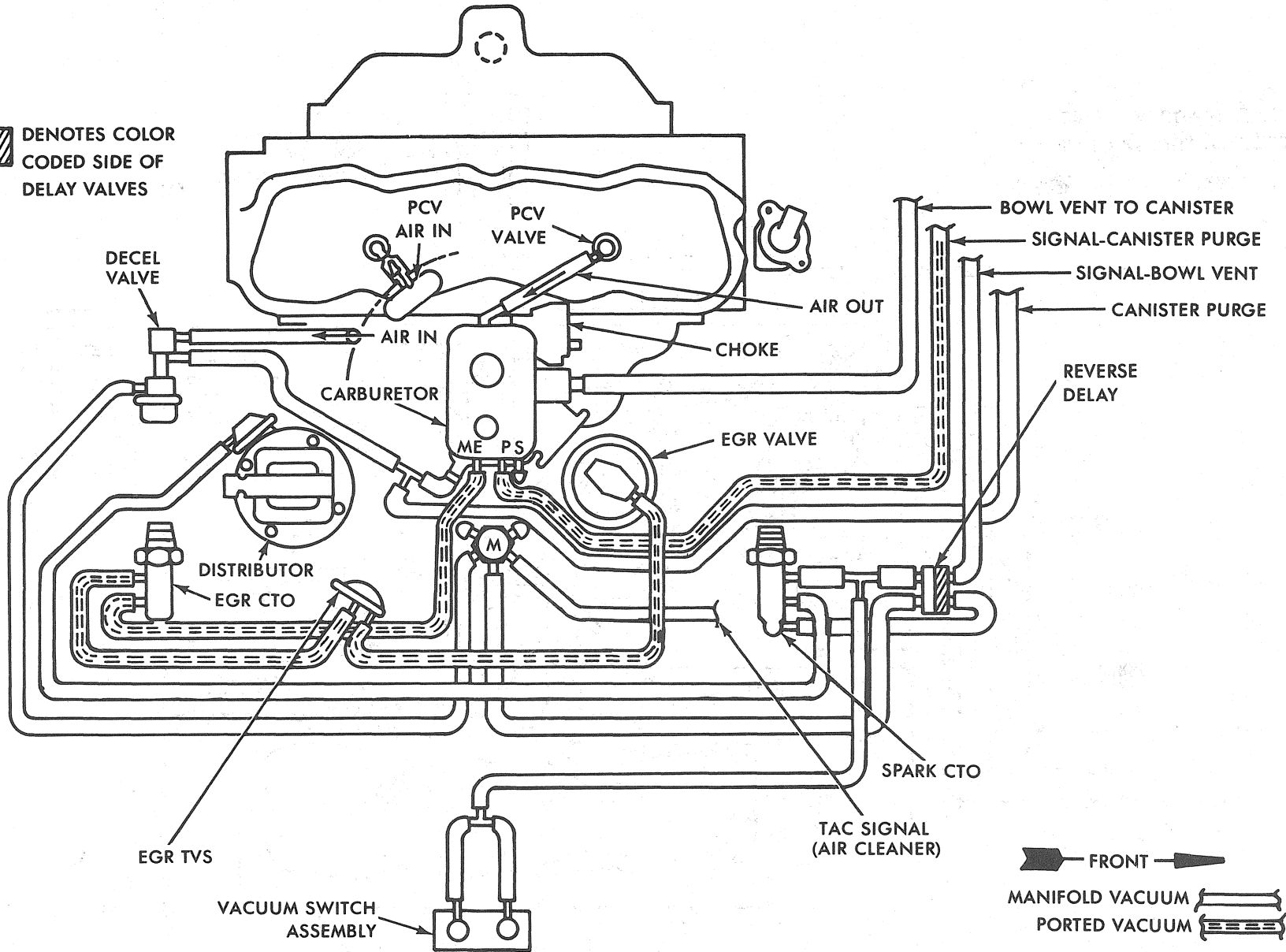

81148F

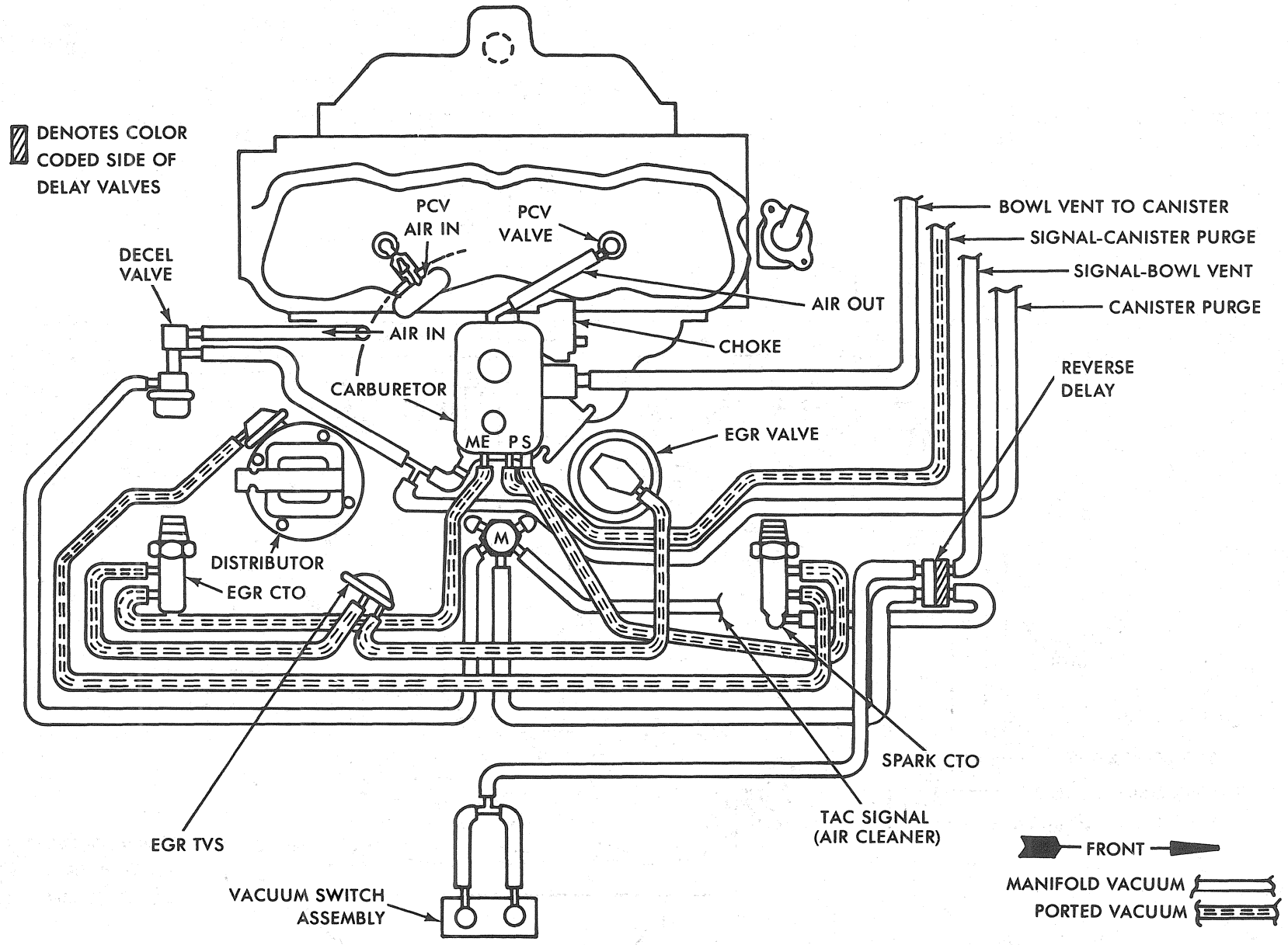

81148G

CALIFORNIA 151 2V WITH AUTOMATIC TRANSMISSION AND STANDARD COOLING CJ 7

 DENOTES COLOR
 CODED SIDE OF
 DELAY VALVES

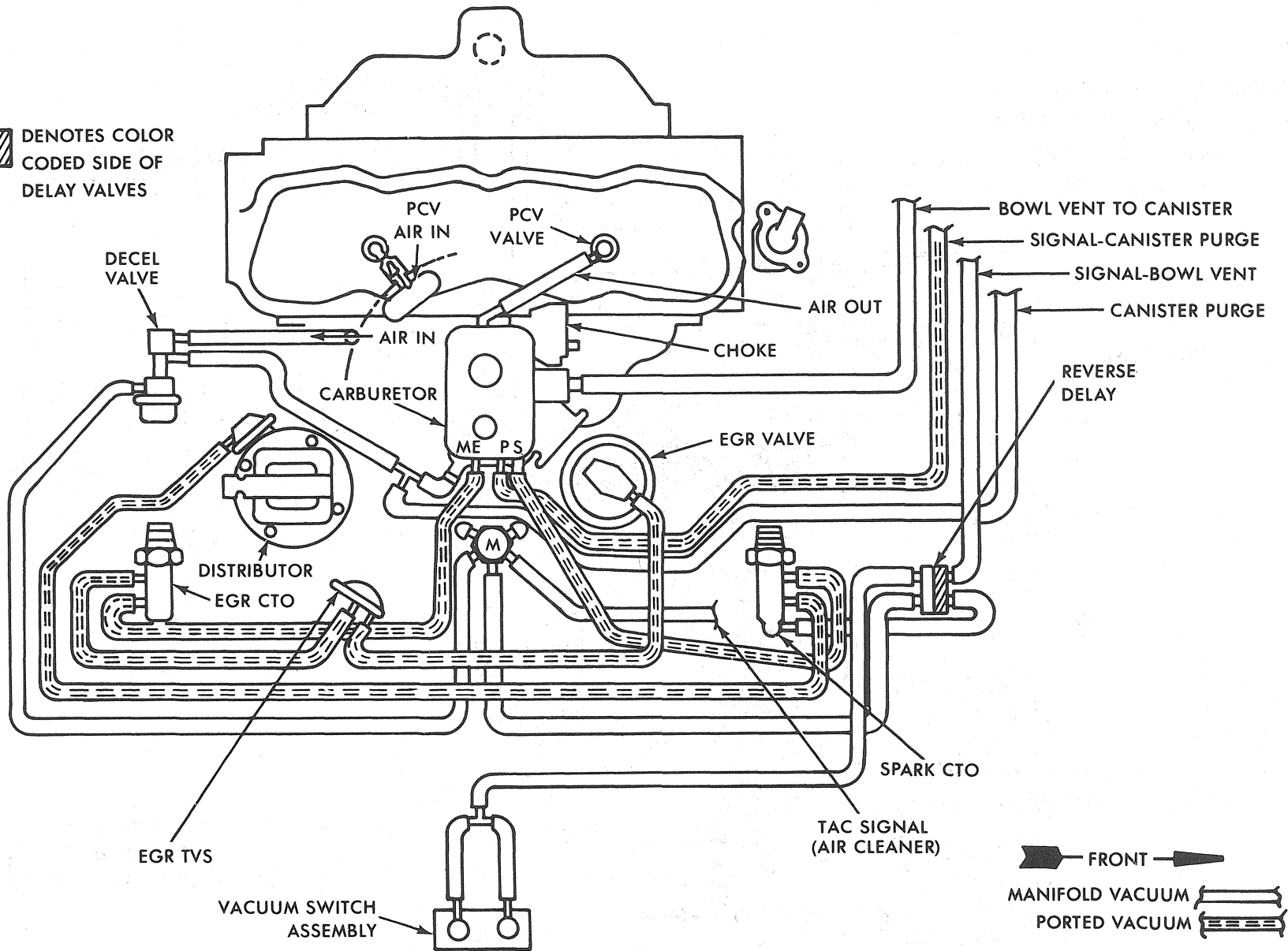

81148H

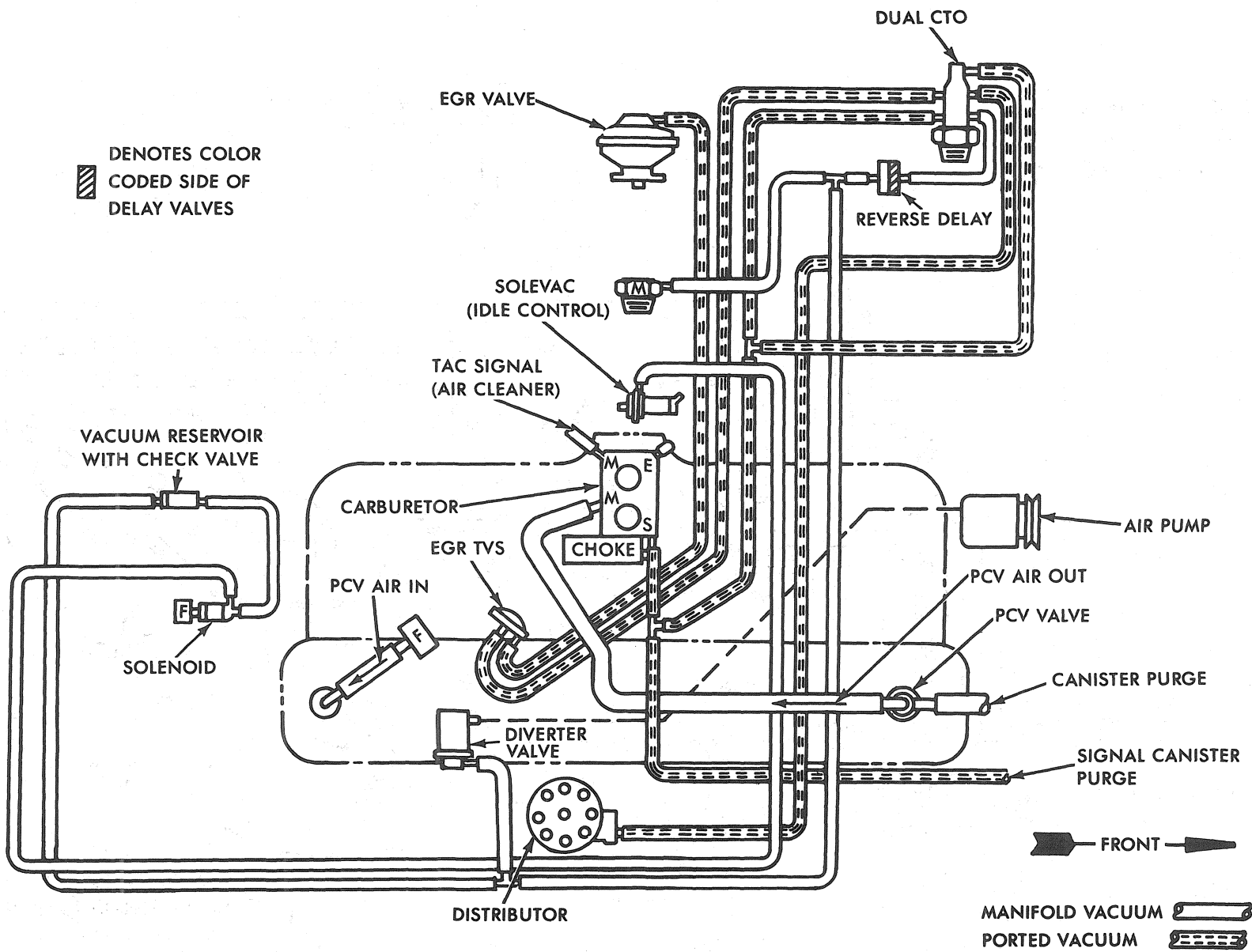

81148J

49 STATE 258 2V WITH MANUAL TRANSMISSION AND STANDARD COOLING ALL MODELS

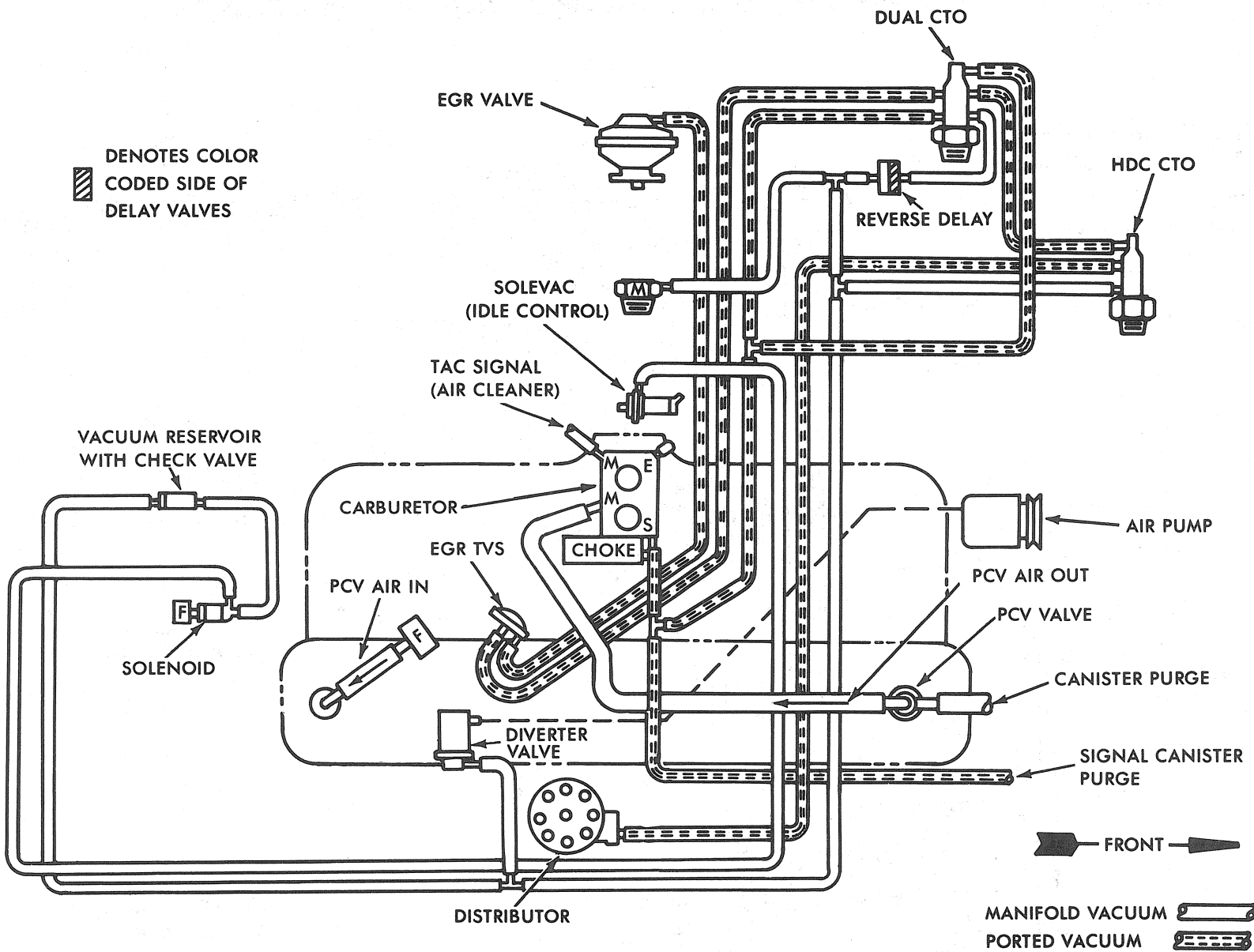

49 STATE 258 2V WITH MANUAL TRANSMISSION AND HEAVY DUTY COOLING ALL MODELS

81148K

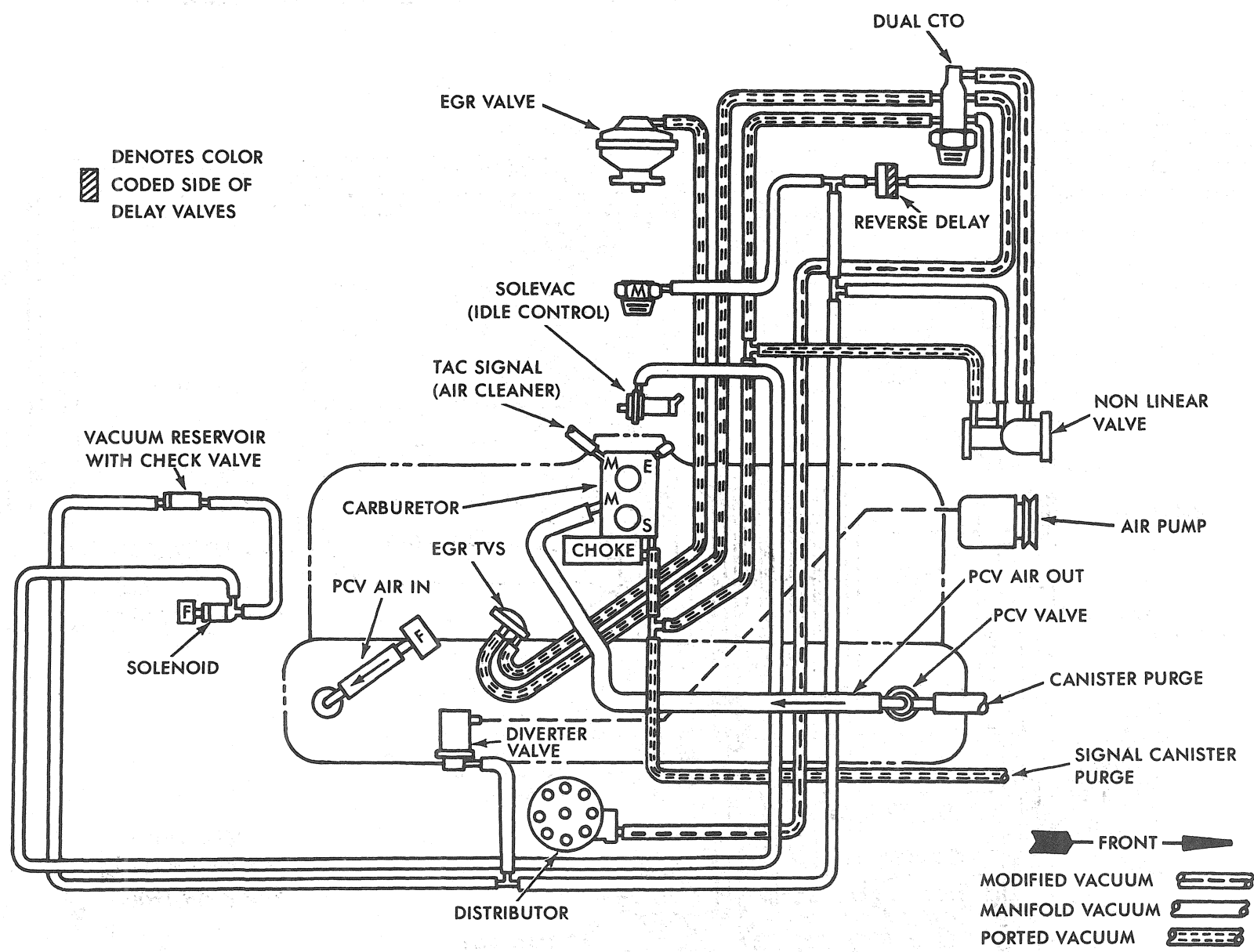

81148L

49 STATE 258 2V WITH AUTOMATIC TRANSMISSION AND STANDARD COOLING ALL MODELS

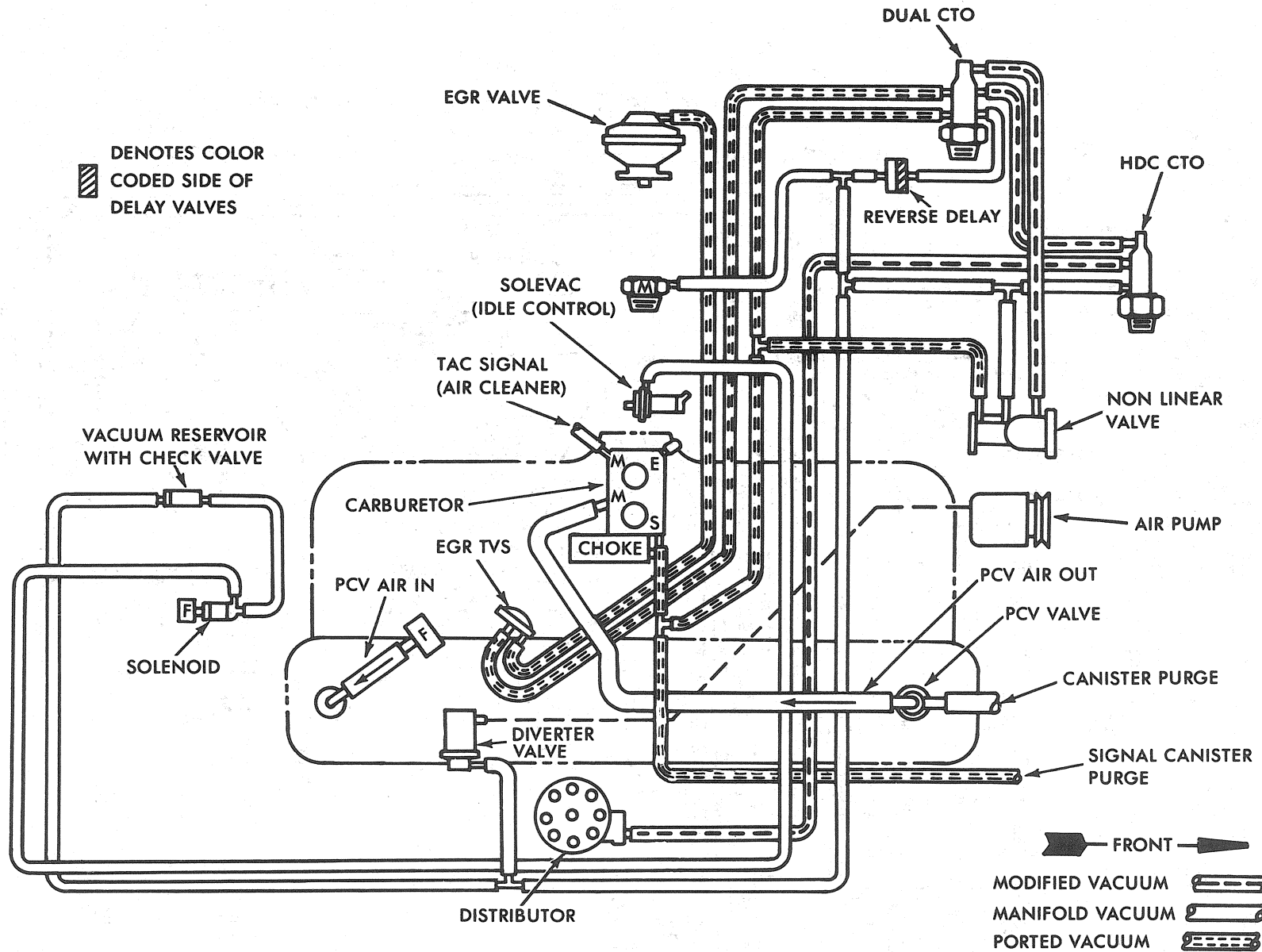

81148M

49 STATE 258 2V WITH AUTOMATIC TRANSMISSION AND HEAVY DUTY COOLING

ALL MODELS

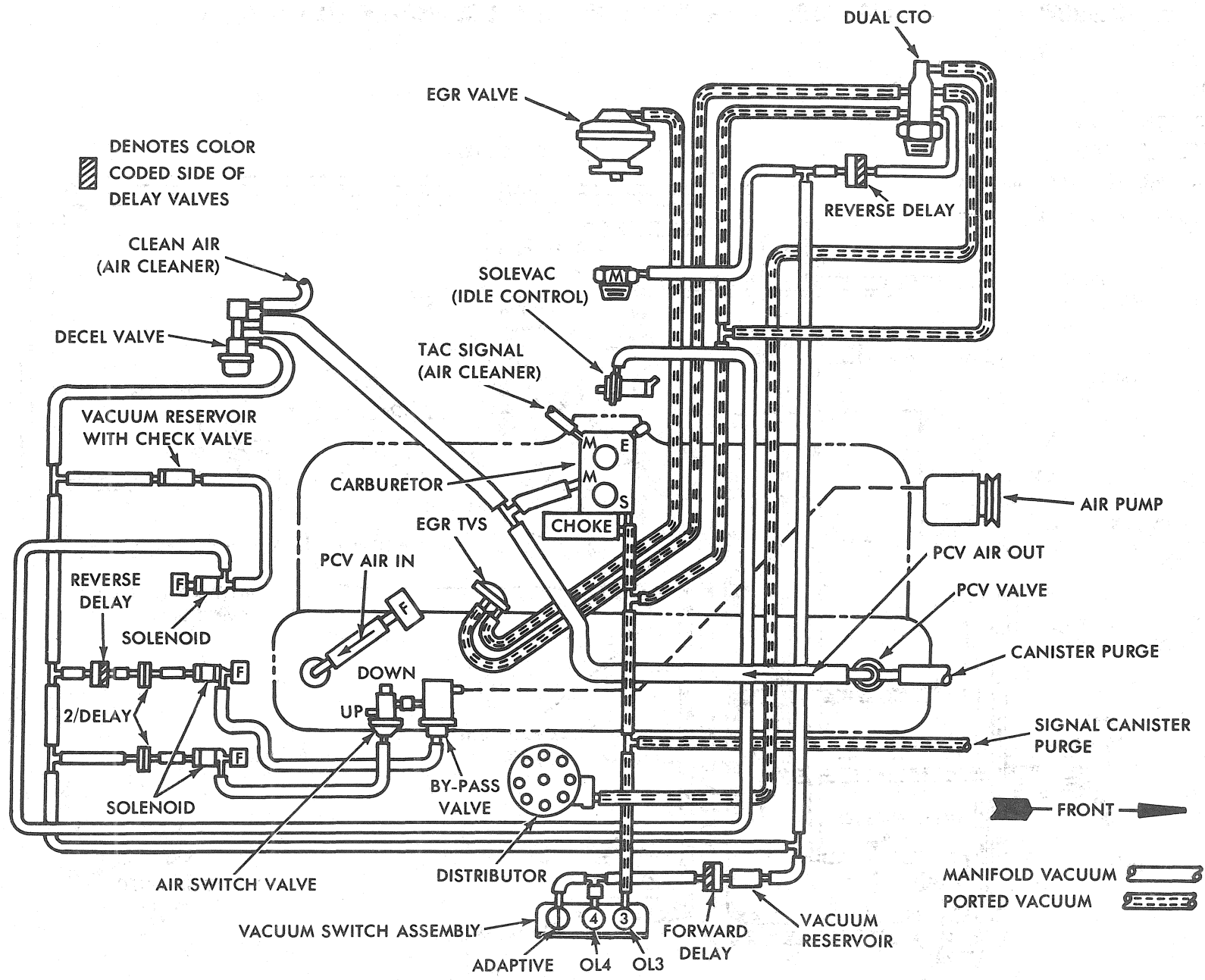

81148N

CALIFORNIA 258 2V WITH MANUAL TRANSMISSION AND STANDARD COOLING ALL MODELS

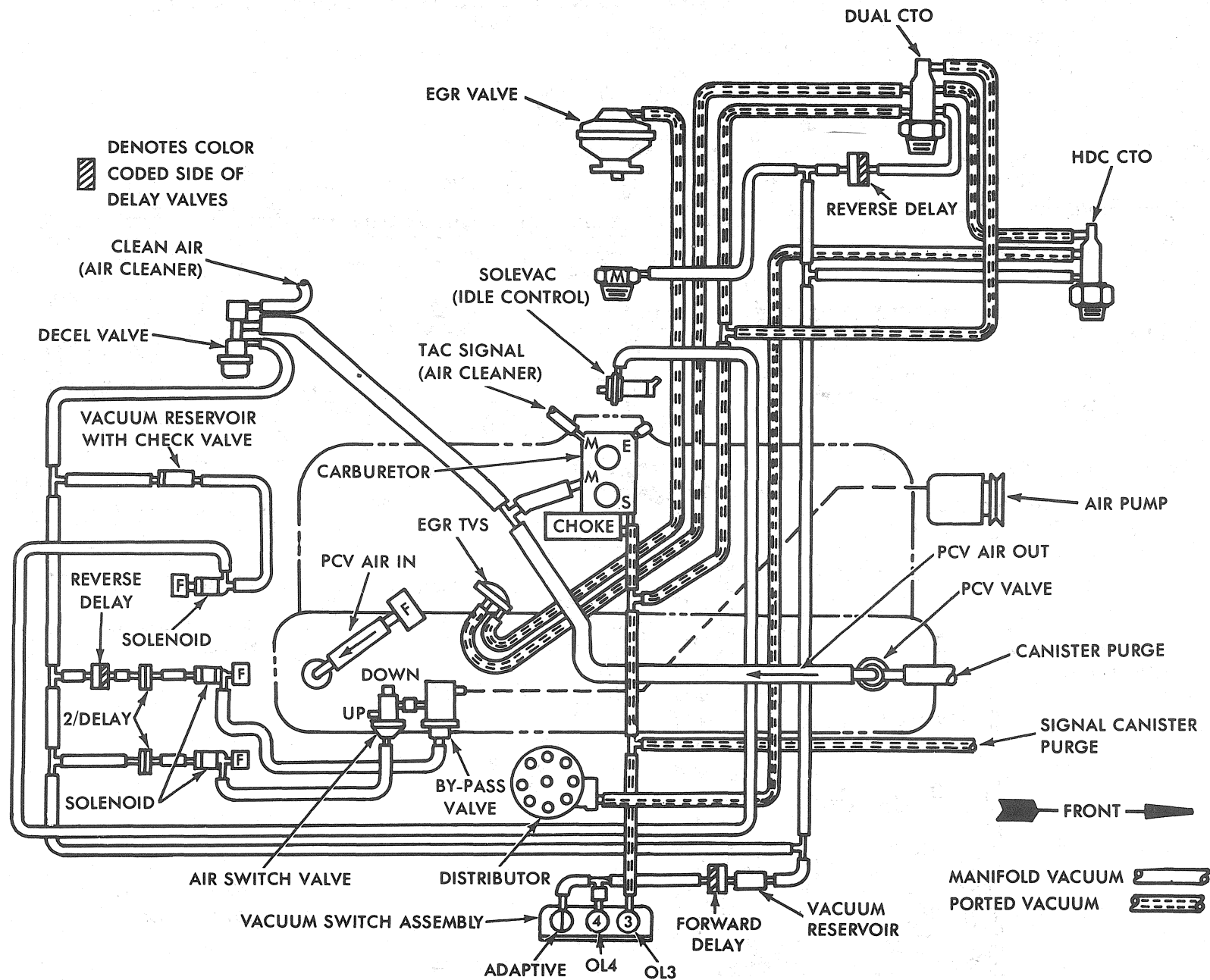

CALIFORNIA 258 2V WITH MANUAL TRANSMISSION AND HEAVY DUTY COOLING

ALL MODELS

81148P

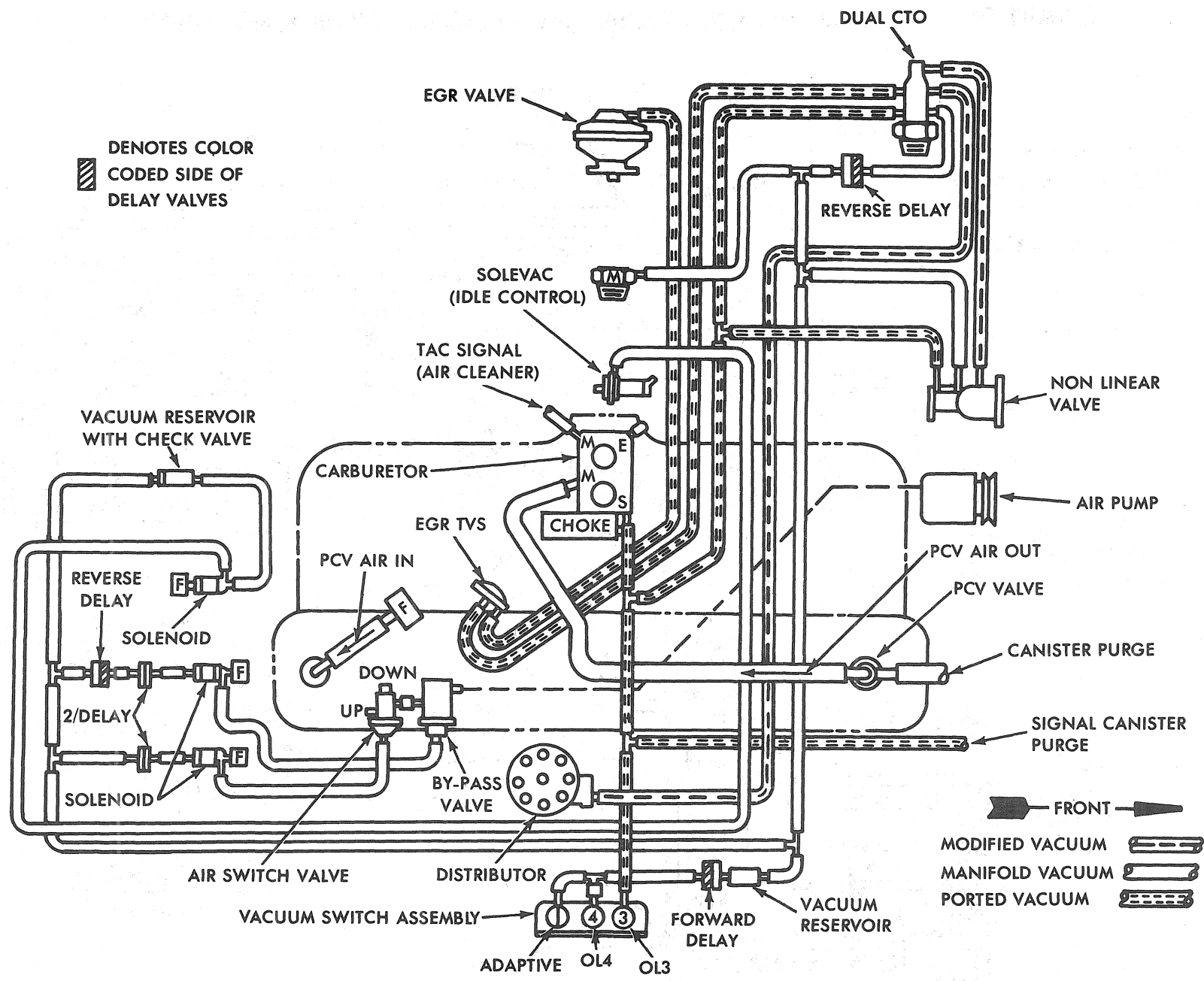

81148Q

CALIFORNIA 258 2V WITH AUTOMATIC TRANSMISSION AND STANDARD COOLING ALL MODELS

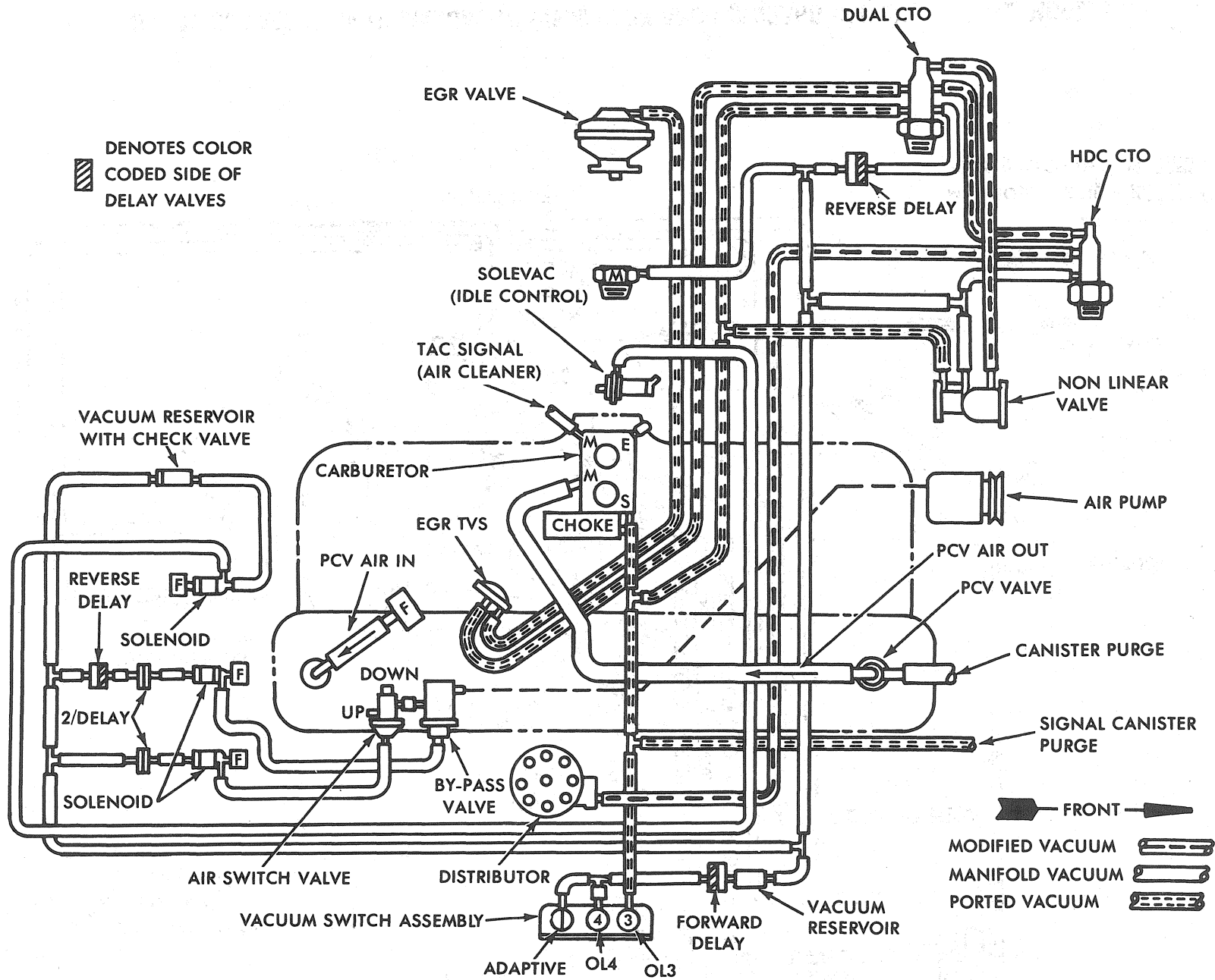

81148R

CALIFORNIA 258 2V WITH AUTOMATIC TRANSMISSION AND HEAVY DUTY COOLING

ALL MODELS

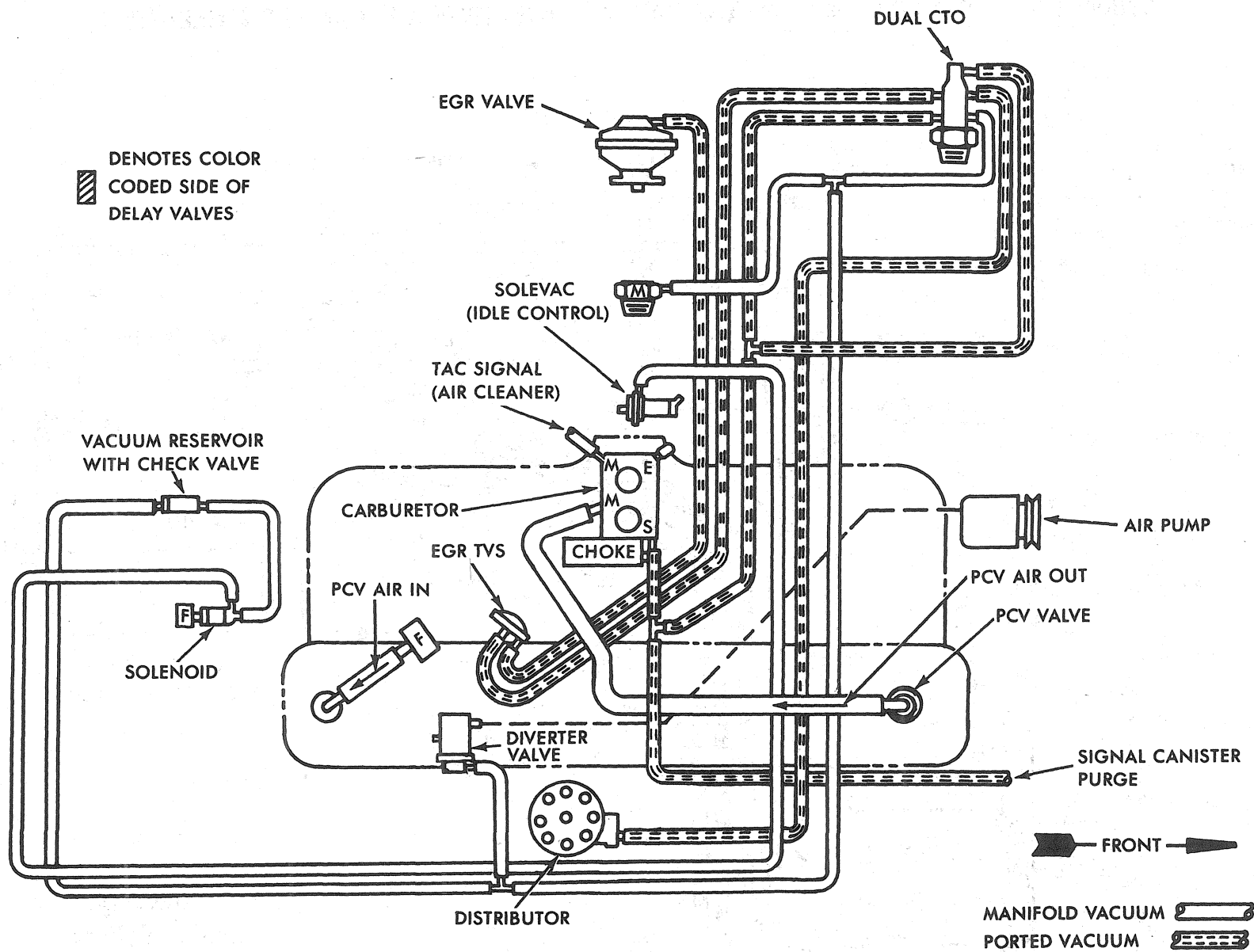

81148S

HI-ALTITUDE 258 2V WITH MANUAL TRANSMISSION AND STANDARD COOLING

ALL MODELS

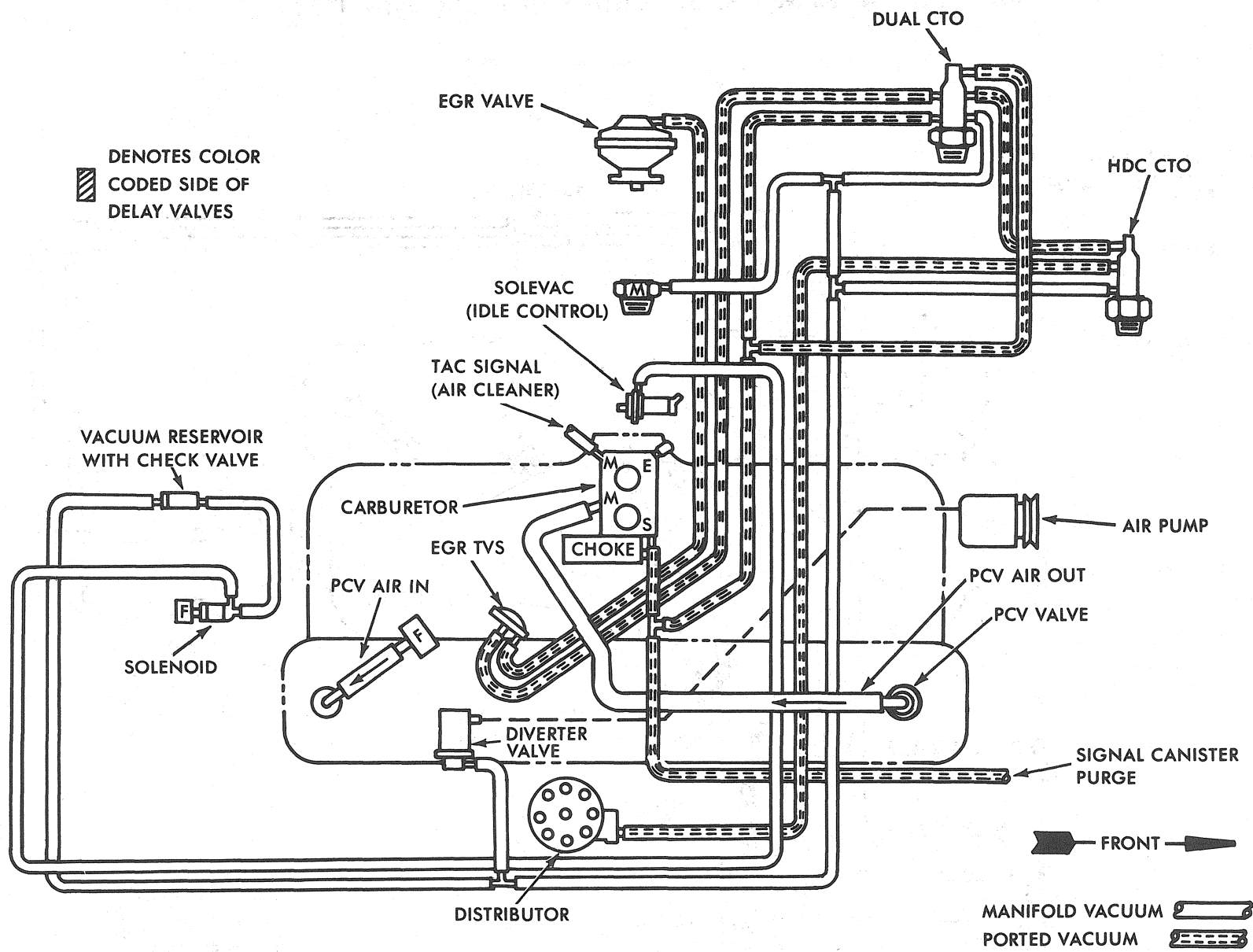

HI-ALTITUDE 258 2V WITH MANUAL TRANSMISSION AND HEAVY DUTY COOLING ALL MODELS

81148T

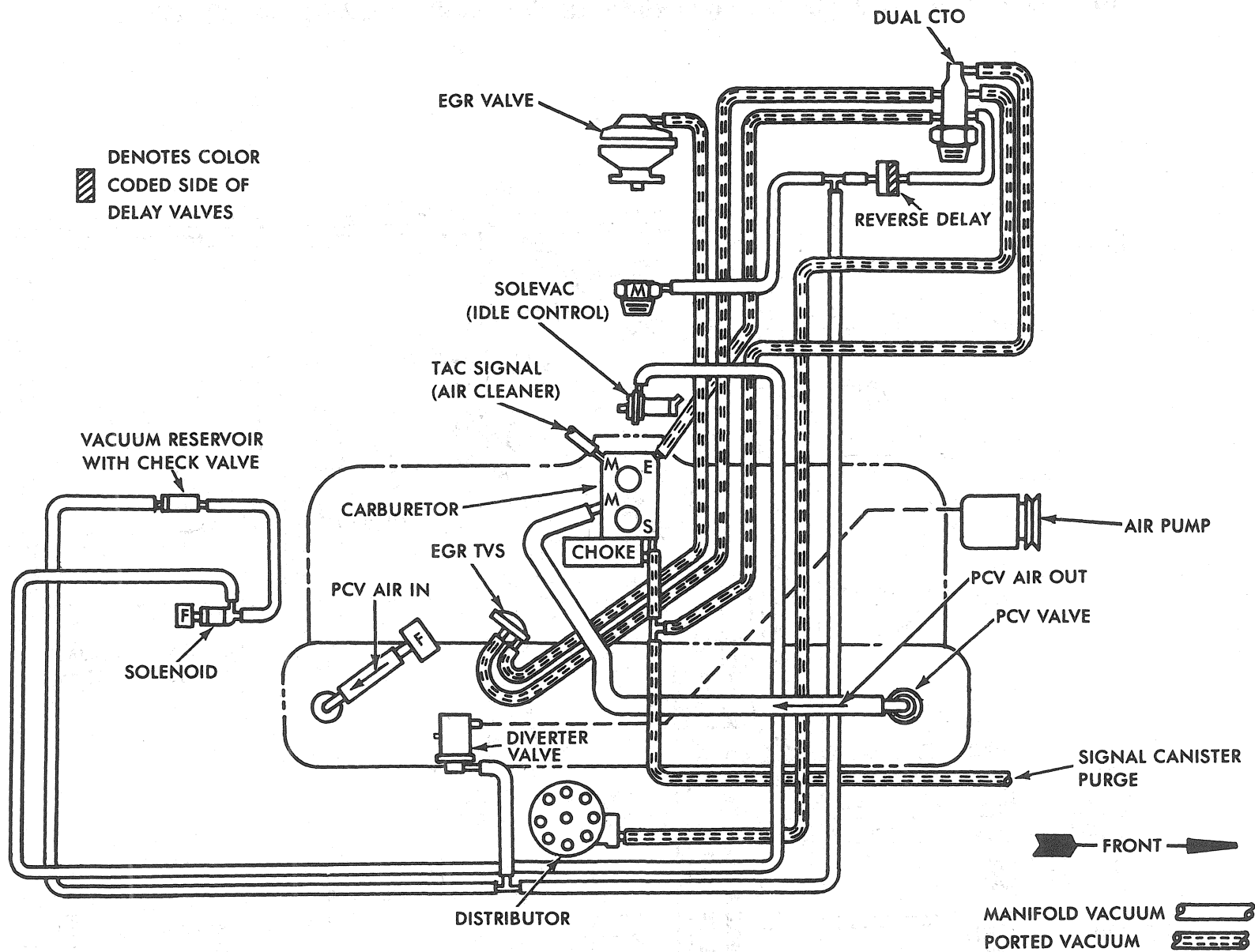

81148U

HI-ALTITUDE 258 2V WITH AUTOMATIC TRANSMISSION

ALL MODELS

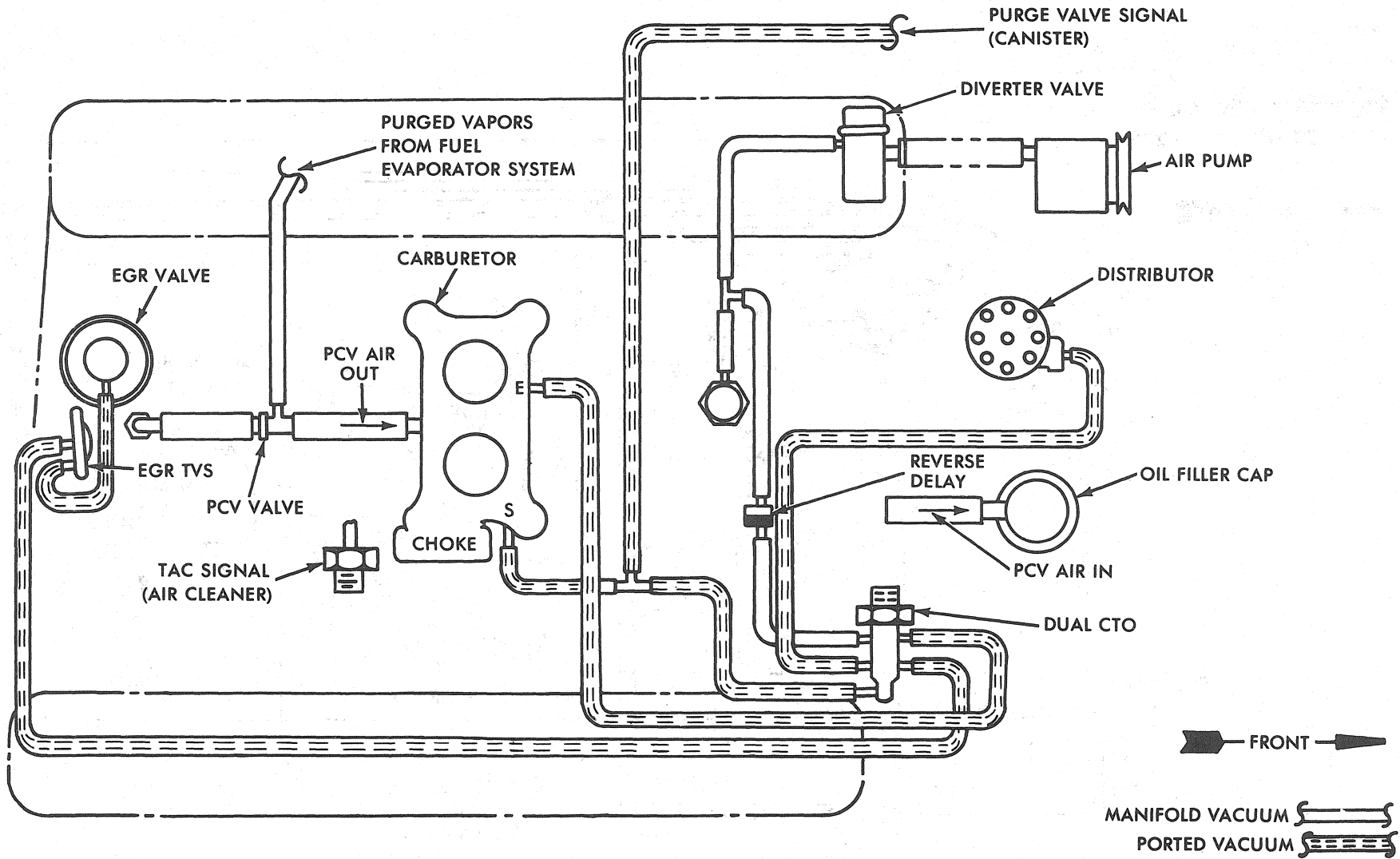

81148V

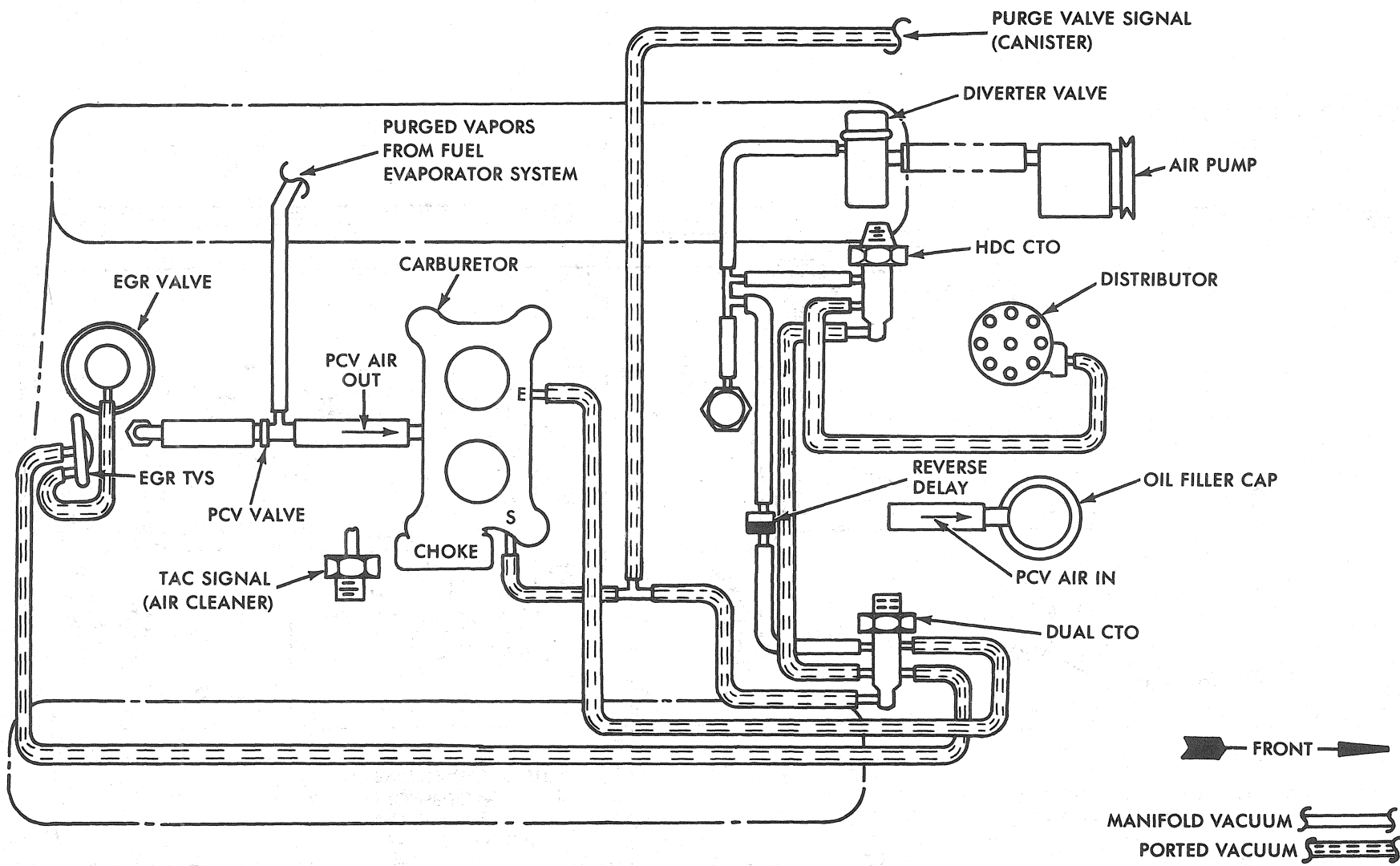

81148W

49 STATE 304 2V WITH MANUAL TRANSMISSION AND HEAVY DUTY COOLING CJ

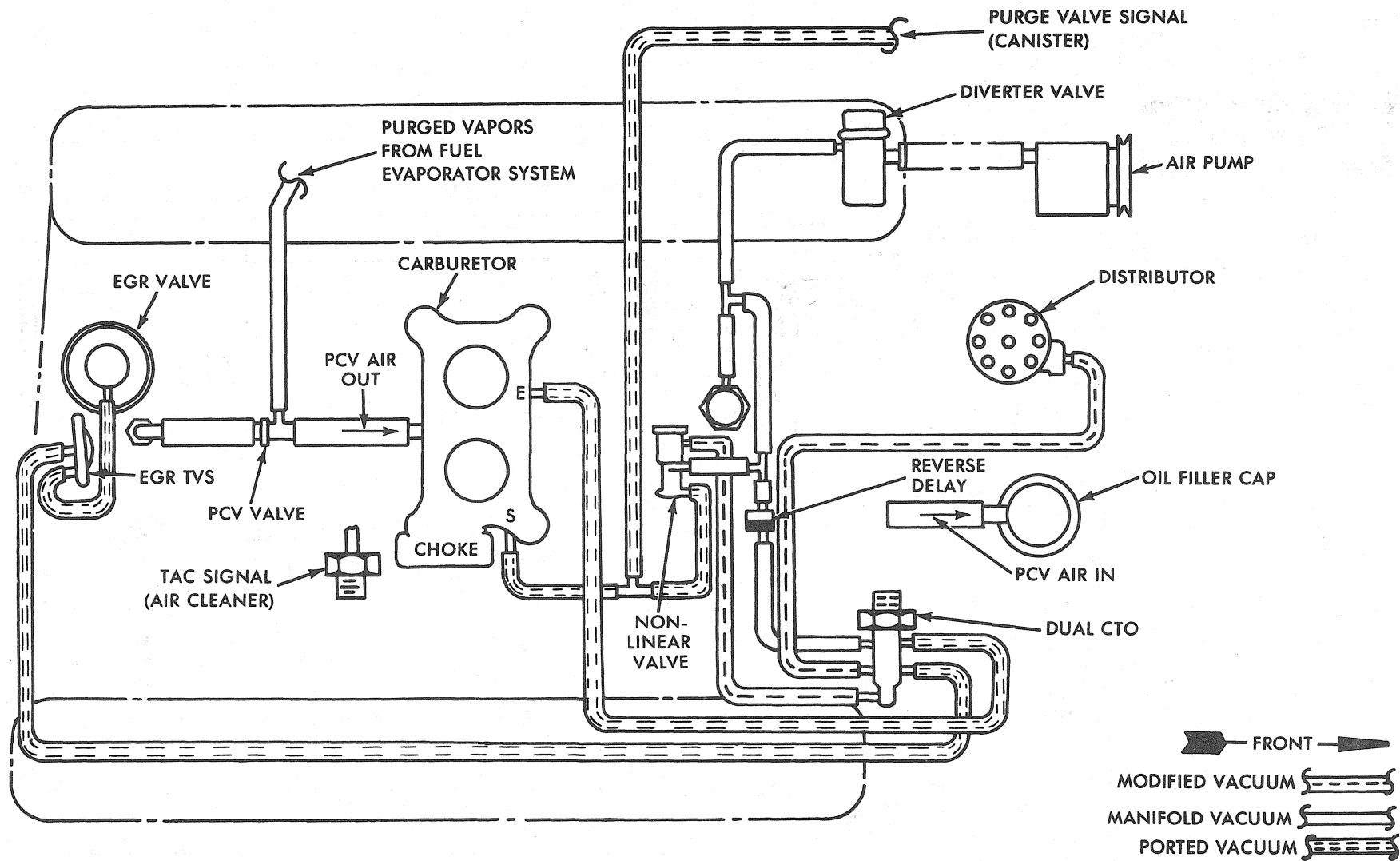

81148X

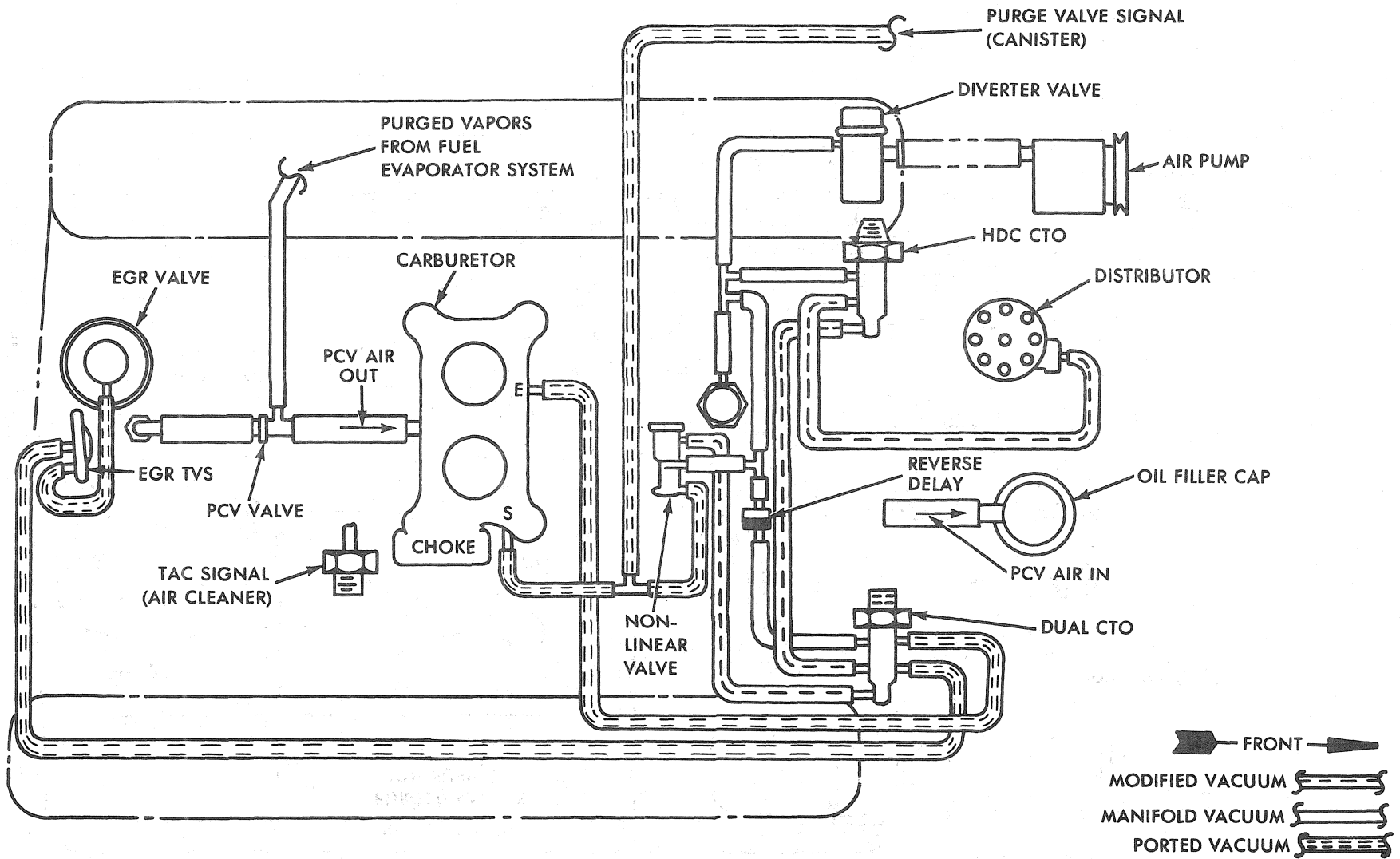

81148Y

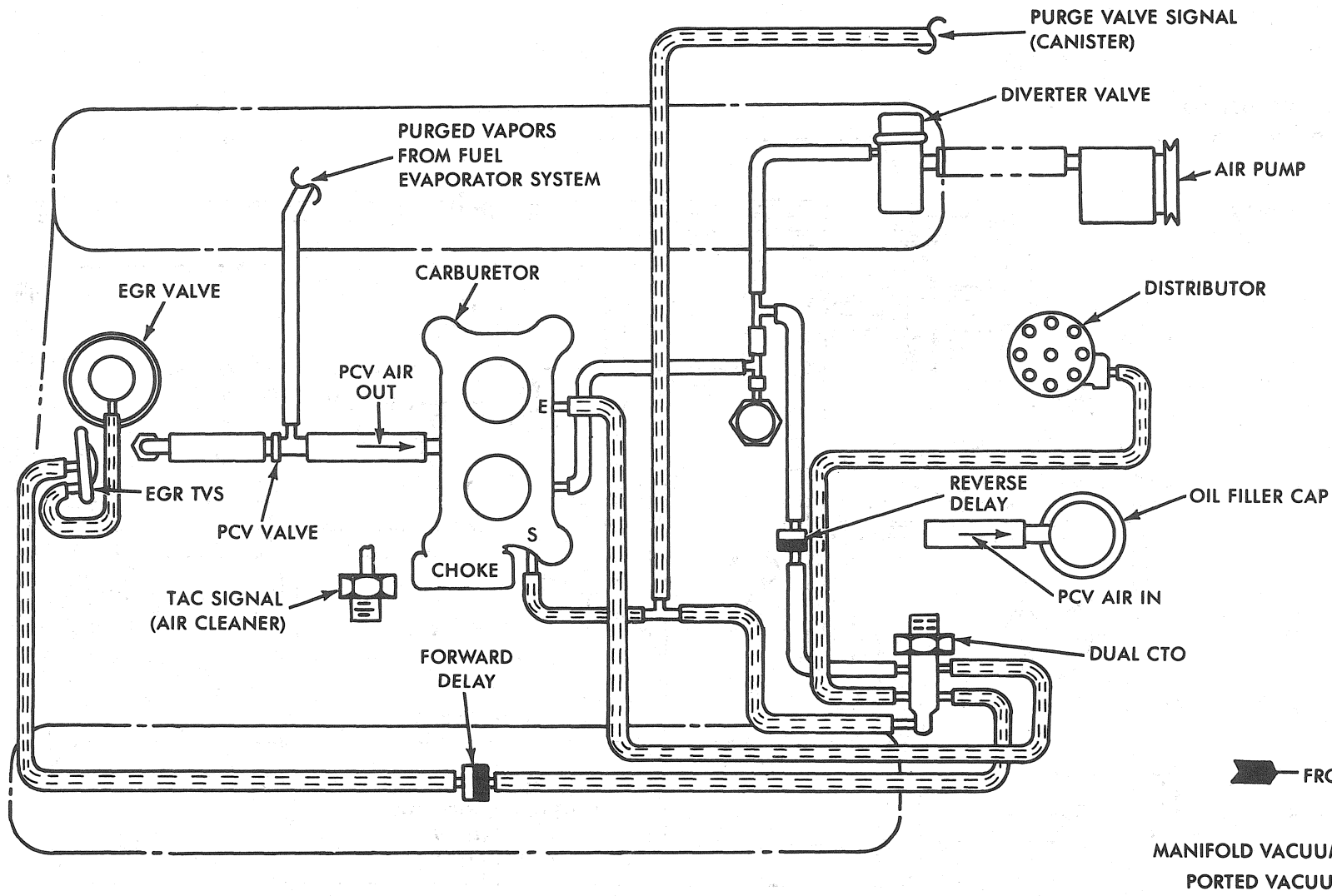

81148Z

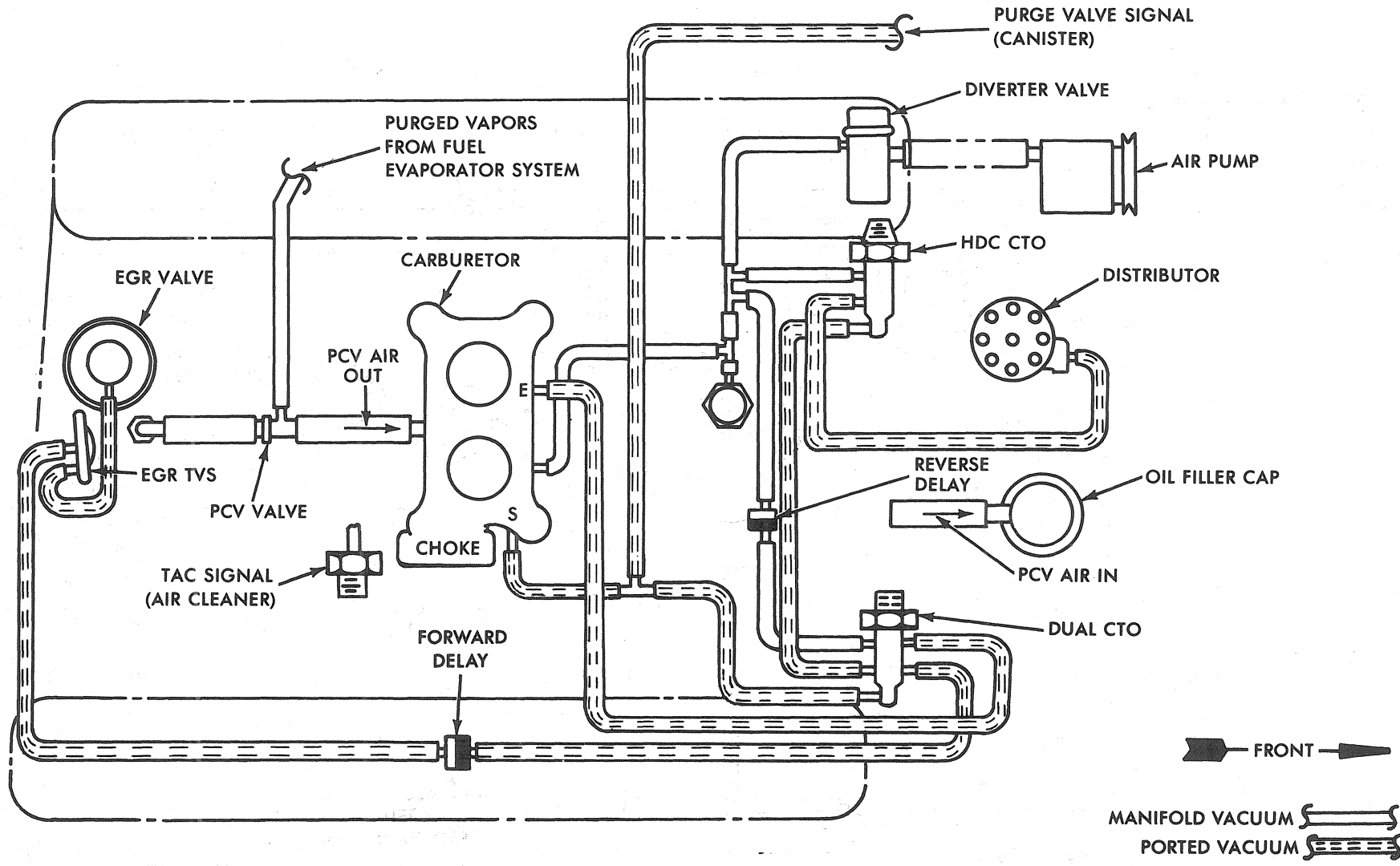

81149A

HI-ALTITUDE 304 2V WITH MANUAL TRANSMISSION AND HEAVY DUTY COOLING CJ

DENOTES COLOR
 [Hatched Box] CODED SIDE OF
 DELAY VALVES

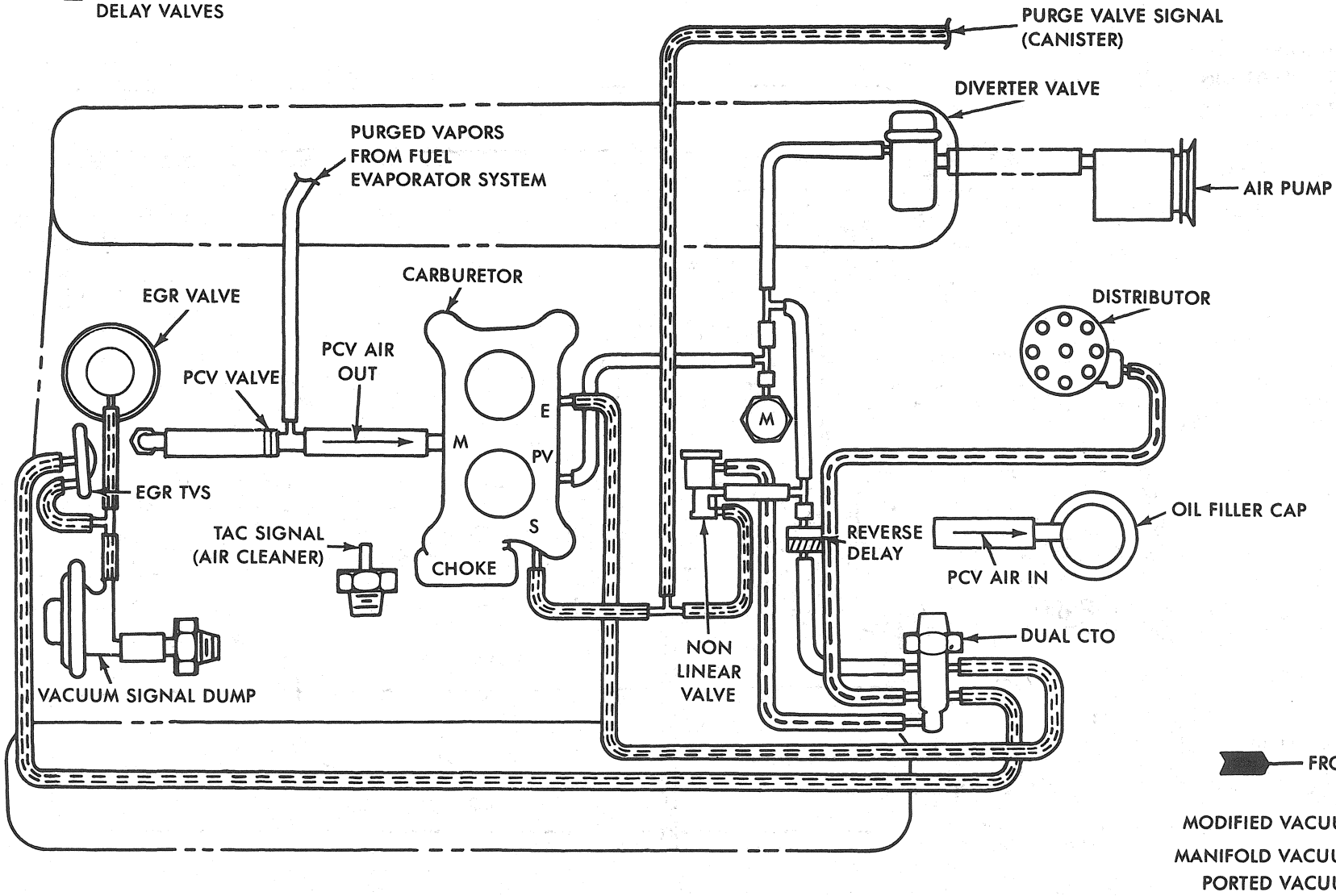

81149B

DENOTES COLOR
 [Hatched Box] CODED SIDE OF
 DELAY VALVES

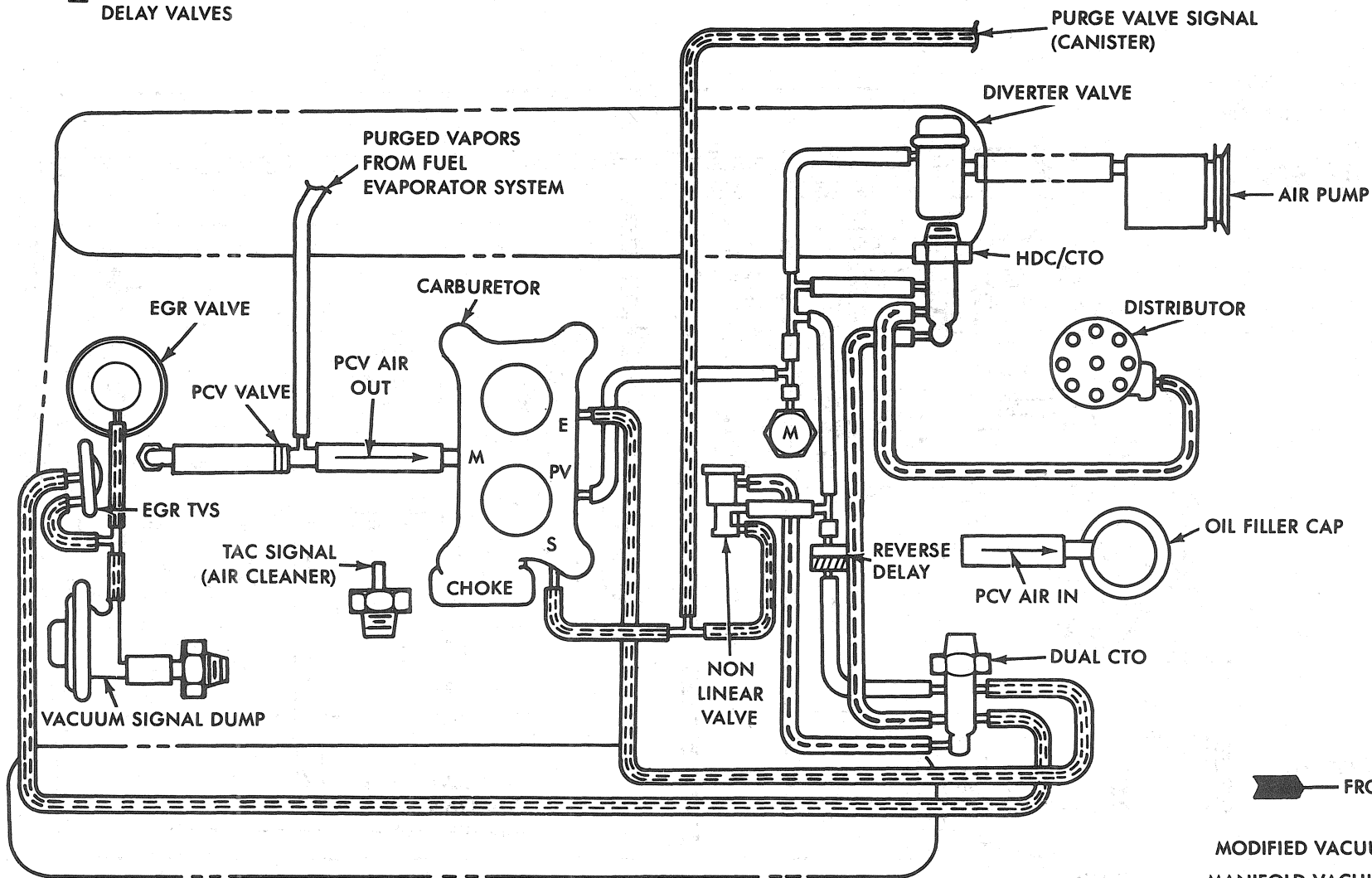

FRONT →

MODIFIED VACUUM [Hatched Box]
 MANIFOLD VACUUM [Solid Box]
 PORTED VACUUM [Dashed Box]

81149C

49 STATE 360 2V WITH MANUAL TRANSMISSION AND HEAVY DUTY COOLING

CHEROKEE, WAGONEER, TRUCK

DENOTES COLOR
 CODED SIDE OF
 DELAY VALVES

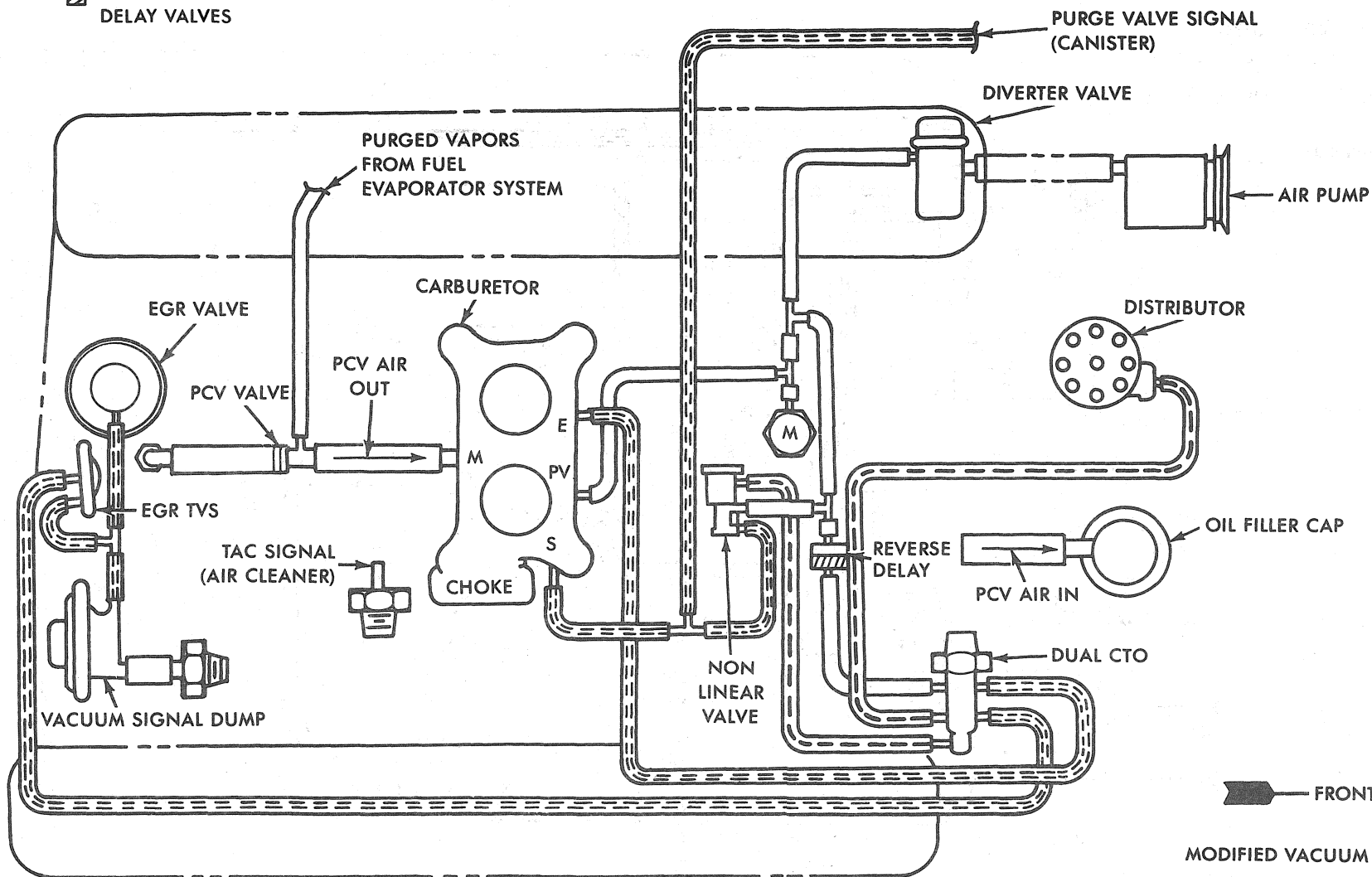

MODIFIED VACUUM 
 MANIFOLD VACUUM 
 PORTED VACUUM 

81149D

DENOTES COLOR
 CODED SIDE OF
 DELAY VALVES

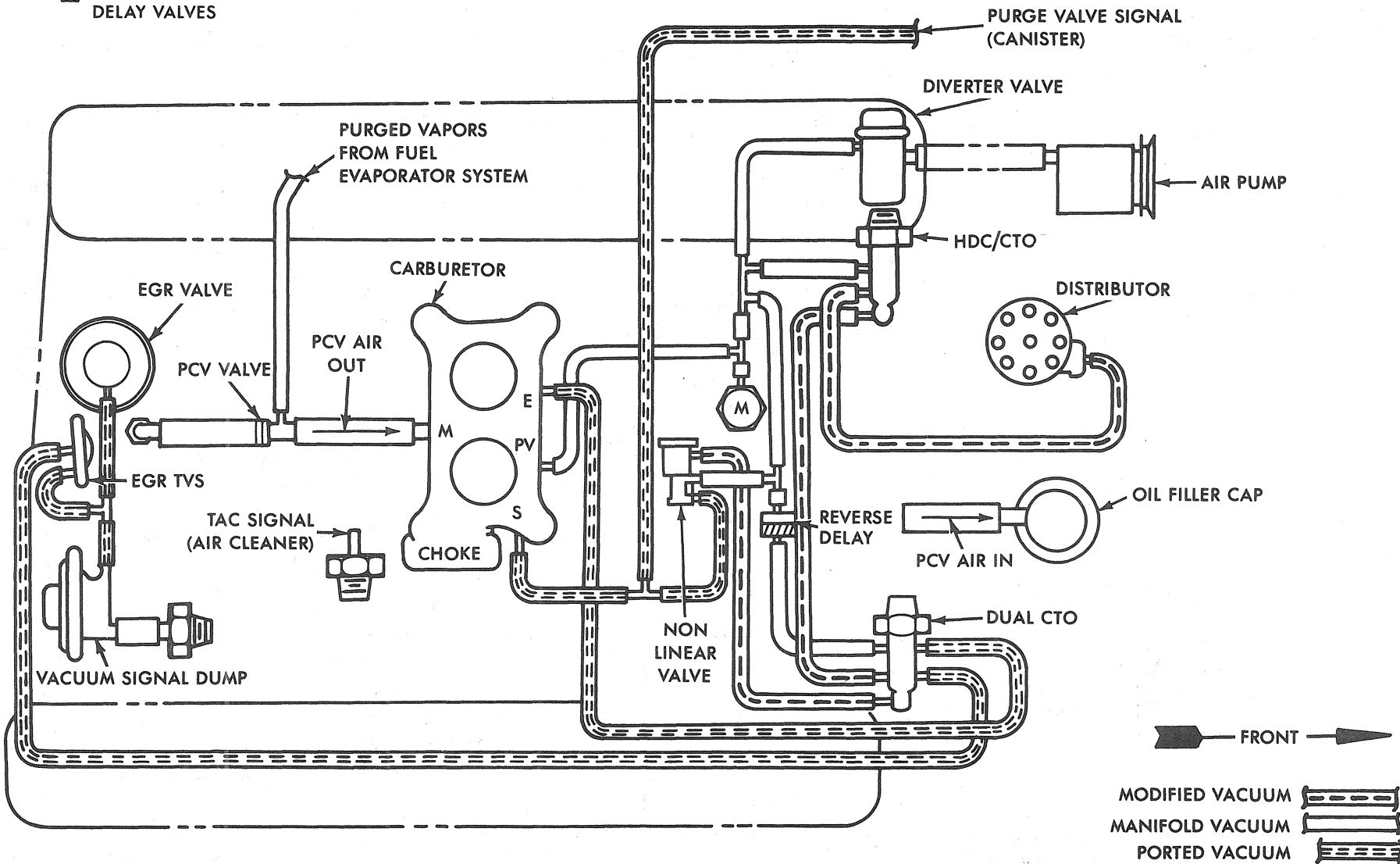

81149E

49 STATE 360 2V WITH AUTOMATIC TRANSMISSION AND HEAVY DUTY COOLING

CHEROKEE, WAGONEER, TRUCK